

請記錄下列產品資料

- 型號 _____
- 機身號碼 _____
- 經銷商名稱 _____
- 購買日期 _____

本產品不斷改進中，如功能有所更改，恕不另行通知，如有疑問，請於客戶服務中心聯繫，不便之處，敬請原諒。

說明書內容以英文版本為準。

ToolBox Customer Service Center 客戶服務中心
7/F., Goodwill Industrial Building, 36-44 Pak Tin Par Street, Tsuen Wan, N.T.
新界荃灣白田壩街 36-44 號信義工業大廈 7 樓

Customer Service Hotline 客戶服務熱線: (852) 8210 8210
Service Email 電郵地址: 8210service@gilman-group.com
Please register now at 請即上網登記: www.toolbox.hk
Website 網址: www.gilman-group.com



Proudly Serviced by



a Gilman Group Company

太平家庭電器

2/F, Shing Dao Industrial Building, 232 Aberdeen Main Road, Hongkong
香港香港仔大道 232 號城都工業大廈 2 樓

gemini
ITALY

Multi-Purpose Electric cooker

多功能電煮食鍋

Model No.: GMC12V

GMC12P

1200W-1400W

Before using your product for first time, please read this instruction manual.
在使用本產品前，請仔細閱讀本說明書並保存好。

IMPORTANT SAFEGUARDS

- When using this multi-purpose electric cooker, basic precautions should always be followed, including the followings:
- Read all instructions.
- Do not touch hot surface, only can touch handles and switch when use.
- Close supervision is necessary when any appliance is used by or near children.
- To protect against electric shock, do not immerse cord, plug or any parts of the machine in water or other liquids. Make sure the power connection inlet is dry before using.
- Do not let cord hang over edge of table or counter, or touch hot surface.
- Do not operate appliances with damaged cord or plug or after the appliance malfunctions, or have been damaged in any manner. Return the appliance to the nearest authorized service center for examination, repair, or adjustment.
- Do not use other mismatched accessory, it may cause hazard or injury.
- Do not place on or near a hot gas or electric burner, or in a heated oven.
- When operating the machine keep at least 10cm of space on all sides of the machine to allow for adequate air circulation.
- Unplug from outlet when not in use and before cleaning. Allow to cool before putting on or taking off parts, and before cleaning.
- To disconnect, turn the switch control knob to OFF position, then remove the plug. Always hold the plug, but never pull the cord. The plug must be removed from the machine before cleaning and maintaining the appliance.
- Extreme cautions must be used when moving an appliance containing hot oil or other hot liquid.
- Do not use metal to touch any part of cooker when operating, creating a risk of electric shock.
- Be extreme cautions when remove the plate or disposing of hot grease or other hot liquid.
- Do not clean with metal scouring pads pieces can break off the coating plate.
- Never leave the appliances unattended while broiling or toasting or other cooking.
- Oversized foods and metal utensils must not be inserted in the plate as they may create a fire or risk of electric shock.
- A fire may cause if the machine is covered or touching inflammable material, including curtains draperies, walls and like, when on operation.
- Do not store any item near the hot plate during operation.
- Do not place any of the following materials when using the cooker: cardboard, plastic, paper or anything similar.
- Do not store any materials, other than recommended accessories in the plate.
- Always wear protective, insulated gloves when inserting or removing any items from the hot plate.
- This appliance is for household use only, do not use outdoor.
- Do not use appliance for other than intended use.
- This appliance can be used by children aged from 8 years and above and persons with reduced physical, sensory or mental capabilities or lack of experience and knowledge if they have been given supervision or instruction concerning use of the appliance in a safe way and understand the hazards involved.
- Children shall not play with the appliance. Cleaning and user maintenance shall not be made by children without supervised.
- If the supply cord is damaged, it must be replaced by the After-sales Service Center or a similarly qualified person in order to avoid a hazard.

- The appliance is incompatible with external timers and remote controlling systems.
- Hot surface during operation. Do not touch the appliance to prevent scald. When opening with the lid, extreme cautions to prevent scald by the steam from the steam hole.
- To avoid the plate over dry burning when preheating, never leave the cooker unattended, else it would damage the coating.
- All the plate/pot must clean asap after cooking soy sauce, otherwise it will make the plate/pot dyeing.

PARTS OF APPLIANCE

- A: Thermostat
- B: Heating plate
- C: Housing of base
- D: Anti-scald handle
- E: Outlet
- F: Indicator light
- G: Temperature control switch
- I: Plug
- J: Lid handle
- K: Steam hole
- L: Steam rack
- M: Grill plate
- N: Deep pot

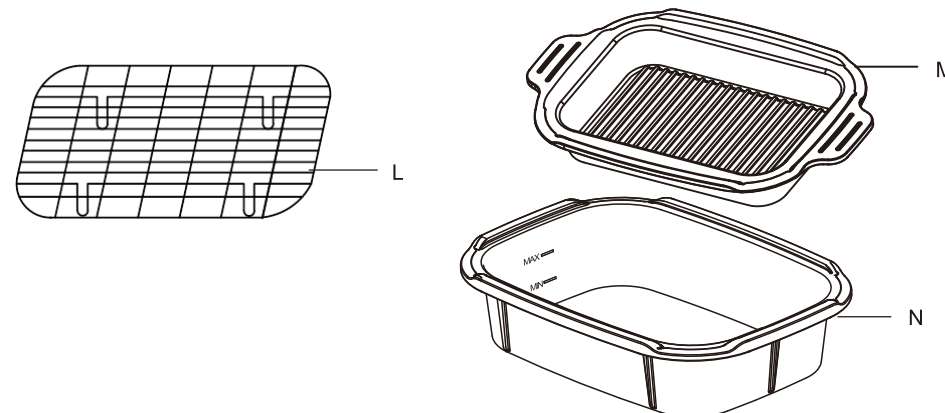
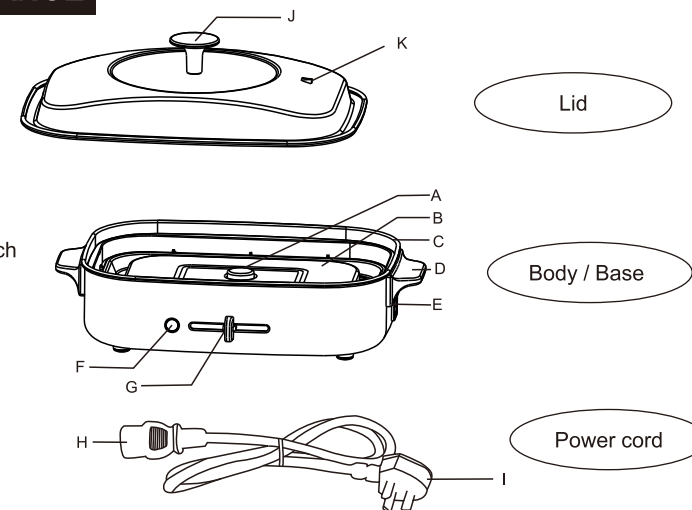

OPERATING INSTRUCTION

Before using your cooker for the first time

Be sure to

- Remove all the plates/pot and lid from the packaging, wash them in water and only use soft cloth or cleaning sponges;
Prohibited washing the machine by water directly, only wipe it with soft cloth scrub;

Waiting all paltes/pot and let completely dry before using.

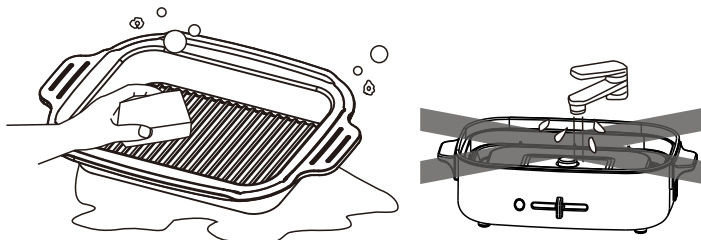

- Place the machine on a flat stable surface and ensure a minimum of 10cm free space distance around the machine. This machine is not suitable for installation in a cabinet or for outdoor use
 - Make sure there is no water and other objects on/near the heating plate or machine.
- Each time only use one detachable plate/pot, can't put more than one plates together during cooking.

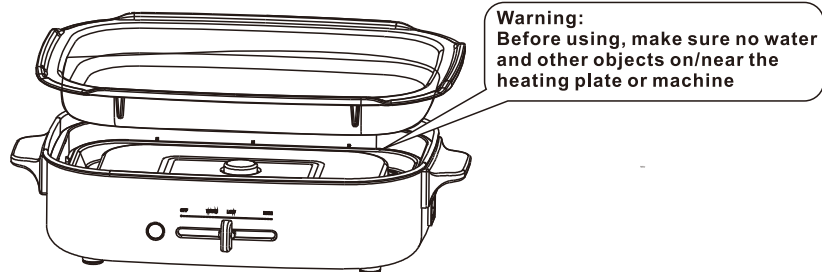

- Connect the inlet into the machine. Plug the power cord into the wall socket and you are ready to use your cooker. (Note: Make sure the voltage which is indicated on the machine matches the local voltage before connecting the machine.)

OFF position

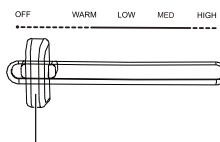

Temperature Control Switch

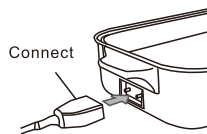

Plug in the socket

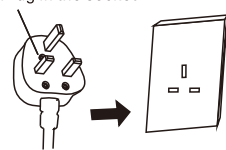

- Preheat: Adjust the switch to the range from "LOW" to "HIGH", start preheating, the indicator light will light up. Please do not cover the lid while preheating.

Range of preheating

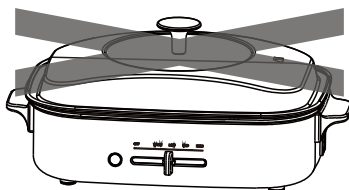

Temperature Control Switch

- The cooker may emit smoke and odors with first time use under normal operating conditions, which

will soon disappear after 5 minutes.

7. The indicator light will light up intermittently indicated, because the thermostat is adjusting the temperature which is normal operation.

8. During use, if you hear the sound of "ka ka", it is normal and caused by heating element.

HOW TO USE YOUR COOKER

- Insert the power plug into the wall socket

- Preheat the cooker with different cooking, Here is the recommended preheat time:

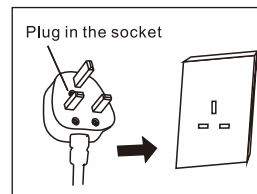

Deep pot: around 5minutes
Grill plate: around 4minutes

- Select the appropriate plate/pot before preheat, put the food inside plate after preheat, then switch to the desired temperature of switch. Only use wooden or silicone Spatula to flip or stir the food



DO NOT USE METAL SPATULA OR SHARP TOOL FOR STIR

Reference temperature for the cooking modes:

Function	Temperature(°C)	Suitable Food (For reference)
WARM	65-80	Keep warm for cooked food
LOW	100-130	Pancake and cakes
MED	160-200	Hamburger. Red bean cake
HIGH	190-245	Barbecue, Grill, Takoyaki, Hot pot, Steam

- Above listed temperature in table is the surface temperature of the plate/pot only, no lid cover and no food or water in the plate/pot.
 - The heat insulation will be different on each plate/pot, please adjust the suitable temperature according to your actual need.
 - When using deep pot, put the food after the water or soup boiling. Please do not pour water or soup over the max indication line. When you cover the lid boiling water long time, there will be some water flow from the edge. It's normal.
 - Don't touch the lid, plate/pot and machine body when cooking. Be careful of electric shock and high temperature. Before cleaning, please ensure all the cooking plate/pot are completely cool down.
 - It is forbidden to clean the plate/pot at a high temperature by water or detergent directly, otherwise it will damage the coating of plate/pot and shorten coating life.
- After cooking, adjust the switch to the "OFF" position. Then remove the plug from socket. Cool down all the cooling plate, take out the plate/pot with insulated gloves, use soft cloth for cleaning.

Plug in the socket

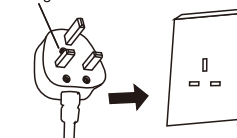

Plug in the socket

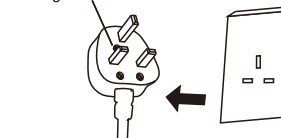

HOW TO USE THE PLATE/POT

1. Grill plate : Grilling makes a new deliciousness
 - Put the grill plate on the heating plate of machine, preheating around 4 – 5 minutes.
 - Place the food to be grilled or cooked in the plate, grill enough time according to different food.
 - Add some water in the groove at the edge of plate, cover the lid until the food fully cooked.
 - After cooking slide the switch to the “OFF” position and let the machine cool down before cleaning.
2. Deep pot: It can be used for Grill / Stir-fry / Roast / slow cook / steam or hot pot functions
 - Put the deep pot on the heating plate of machine, preheating around 4 – 5 minutes .
 - If boiling food, please make sure the water is boiled before adding the food inside pot
 - Steam rack can be used with the deep pot for steaming any food you like.
 - After cooking, slide the switch to the “OFF” position and let the machine cool down before cleaning.

CLEANING

1. It is important that you clean the machine after each use to prevent an accumulation of grease and avoid unpleasant odors.
2. The machine must be cool down and unplug from outlet before cleaning.
3. Do not immerse machine in water or wash it under waterspout.
4. Removable plate/pot can be washed, only use soft cloth, can't use dishwasher.
5. Wipe the outer surface of machine with damp cloth.
6. Do not use abrasive cleaner or sharp utensils to clean the plate/pot rack and lid, as scratching may weaker it and cause shattering,
7. Let all removable accessories and surfaces dry thoroughly.

PRODUCT SPECIFICATION

Model No. : GMC12V(purple colour) GMC12P (pink colour)

Power: 1200-1400W

Voltage/frequency: 220V~240V 50/60Hz

Product dimension without plate/pot: 390 (W) x 245 (H) x 145 (D) mm

安全注意事項

1. 在使用本產品前，請遵循以下基本安全措施。
2. 仔細閱讀本使用說明書。
3. 使用時禁止觸摸熱表面，只能觸碰防燙把手和開關
4. 在使用多功能鍋時，不允許兒童操作或接近多功能鍋。
5. 為防止觸電，嚴禁將電源線，插頭浸入水中。確保使用前插頭處於完全乾燥狀態。
6. 電源線不能接觸主機的受熱面，不要讓電源線懸掛在桌子或櫃檯邊緣或接觸發熱表面。
7. 電源線、插頭、附件損壞或電器設備出現故障的情況下，為避免危險切勿繼續操作本產品，請聯繫本公司的客戶服務中心並攜帶產品到指定維修中心檢查或維修。
8. 不要使用非本機附送的配件，以免發生危險及造成傷害。
9. 不要將多功能鍋放在靠近熱水器，電爐或微波爐等熱源的地方。
10. 在使用多功能鍋時，要保證主機的每一邊至少有 10 厘米的空間，讓空氣流通。
11. 當不使用多功能鍋或清潔時，請先拔掉電源線插頭，要先冷卻才能進行拆卸配件。
12. 不使用時，需把電源線拔除，將開關撥調到“OFF”位置，然後拔下電源插頭，拔下插頭時，請務必抓住插頭，不要拉扯電源線。
13. 注意，清洗前和維護該產品前，插頭一定要處於未接通電源的狀態。移動裝有熱油或其他高溫液體的器具時，必須格外小心。
14. 使用時，不要用金屬器具去接觸多功能鍋的任何部件，防止觸電。
15. 移動烤盤或處置熱油脂或其他高溫液體時要格外小心。
16. 使用時，不要使用帶金屬的刷子去清潔，因可能與帶電部件接觸，造成危險。
17. 當多功能鍋在使用時，請注意有人看管。
18. 體積較大的食物或玻璃及塑膠類的器皿切勿放入烤盤內烘烤，以免危險。
19. 不得用多功能鍋主機存放任何物品或易燃物品（如窗簾，牆紙等），容易釀成火災。
20. 多功能鍋使用時，周邊不得放置任何易燃物品（如窗簾，牆紙等），容易釀成火災。
21. 請勿將紙板，塑膠，紙等類似易燃物品放在烤盤內加熱。
22. 不要把非本機配備的配件放在主機上使用。
23. 在取下或替換烤盤時，一定要帶上防護套或隔熱手套。
24. 本產品只可作家庭用途，不能放置戶外使用。
25. 不可讓本產品作非指定用途使用。
26. 該電器可適用於 8 歲以上的兒童以及身體，感官或者智力能力下降和缺乏經驗和知識的人群，他們使用該電器需要得到安全使用電器的監督或者指導，並且瞭解所涉及的危險。
27. 成人應該指導小孩不可把玩此電器。
28. 定期檢查本產品的電源線。如果電源線損壞，必須由本公司售後服務部或合格的電器技師更換，以避免危險。

29. 本產品沒有外部定時器和遙控器，不可私自安裝外部定時器。
30. 使用時，產品表面以及烤盤表面溫度非常高，不要觸碰機身和烤盤，防止燙傷。揭開蓋子時，注意避開蒸汽孔，防止燙傷。
31. 避免烤盤預熱時過度幹燒，切勿在烹煮過程中離開本機，可能對烤盤塗層造成損壞。
32. 所有烤盤/深鍋煮完帶醬油或者深色的食物，必須要及時清潔，否則米黃色的烤盤會被染上醬油色等顏色。

產品部件

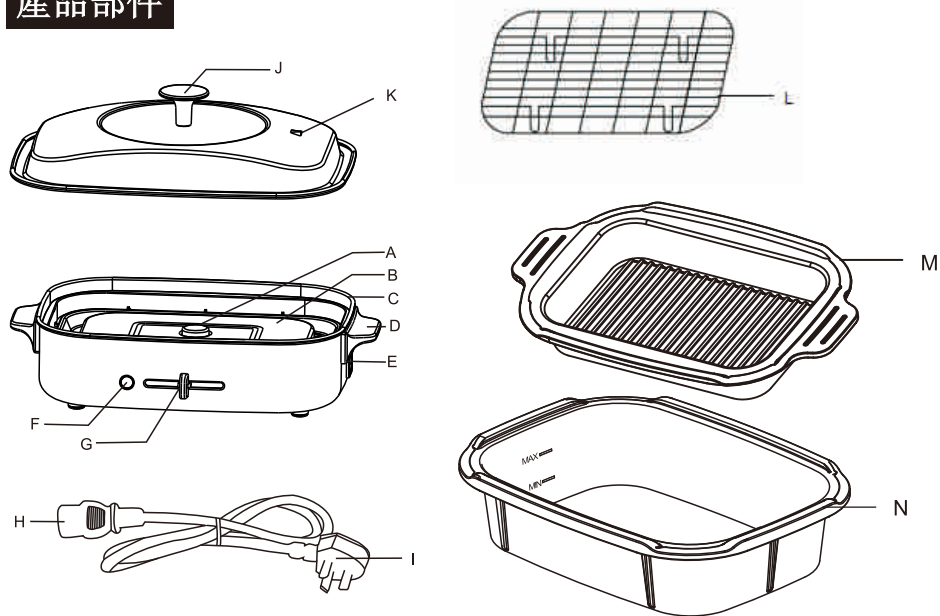

- | | | | |
|----------|----------|---------|-------|
| A. 感應溫控器 | E. 電源線接口 | I. 插頭 | M. 烤盤 |
| B. 發熱盤 | F. 指示燈 | J. 鍋蓋提手 | N. 深鍋 |
| C. 主機外殼 | G. 溫度調節桿 | K. 蒸汽孔 | |
| D. 防燙把手 | H. 電線接口 | L. 蒸架 | |

操作指南

首次使用

初次使用多功能電煮食鍋前，請確保

1. 從包裝箱里拿出所有烤盤，並用軟布和中性洗滌劑清潔；主機不可直接浸水，可用軟布清潔機身；完全擦乾所有配件，即可以開始使用。

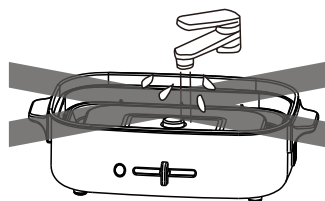
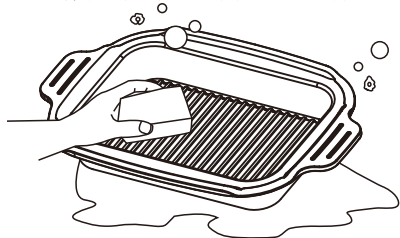

2. 將多功能鍋放置在平坦的桌上，確保主機周邊留有 10 厘米左右的距離用作空氣流通。多功能鍋不能放在壁櫥和戶外使用。
3. 接通電源前確保主機發熱盤與烤盤之間沒有任何異物，每次只能使用一個烤盤或深鍋于主機上，烤盤或深鍋不能疊在一起使用。

注意事項

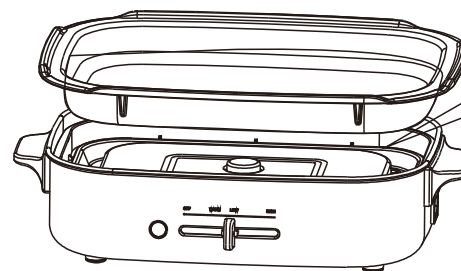

使用前請先確認發熱盤內有無異物

- (1) 在烤盤/深鍋和主機之間，請確認沒有異物和水分。
- (2) 將主機和烤盤放置好後，請確認沒有傾斜。
- (3) 請勿使用金屬刀、鏟等工具。

4. 電源線連接：

- 1) 檢查本產品底部的電壓及功率是否與插座電壓一致；
- 2) 確保溫度調節桿處於“OFF”位置；
- 3) 將電線插頭穩妥接於機身接口；
- 4) 將電源線的插頭接入牆身插座。

OFF 位置

OFF WARM LOW MED HIGH

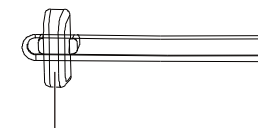

溫度調節桿

插上電源

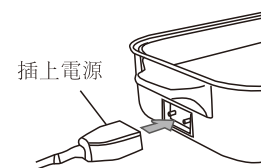

插上電源

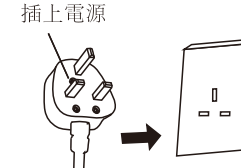

5. 預熱：使用前將溫度調節桿調到“LOW”到“HIGH”的範圍內進行預熱。預熱時不能使用鍋蓋。

預熱溫度範圍

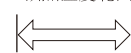

OFF WARM LOW MED HIGH

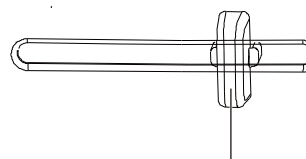

溫度調節桿

注意：
預熱時，無需加上蓋子

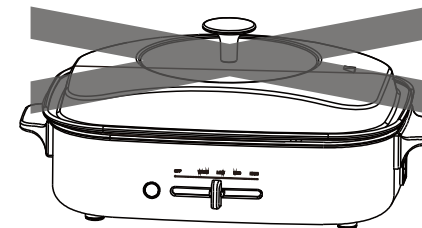

6. 初次使用時，產品可能冒煙或有氣味，這是由於發熱盤上的保護油導致，是正常現象。隨著使用大約 5 分鐘後會逐漸消失。
7. 使用時，指示燈時亮時滅，是溫控器調節溫度的表現，這並非故障。
8. 使用期間出現“咔咔”聲是發熱盤受熱膨脹所致，並非故障。

如何使用多功能鍋

1. 插上牆上的電源插頭

插上電源

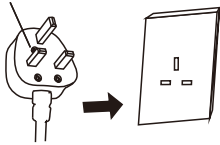

2. 根據實際烹飪的食物，選擇附送的容器。不同容器的預熱時間只供參考：

深鍋:大約 5 分鐘.
蒸汽烤盤: 大約 4 分鐘.

3. 根據個人喜好選擇合適的容器將食物放入烤盤/深鍋。烹飪食物時，只能使用木質或硅膠鍋鏟翻炒，不可使用金屬鍋鏟或器具翻炒食物，避免刮傷塗層。



請勿使用金屬刀鏟等工具翻炒食物

使用時，主機刻度對應的溫度參考值：

主機的溫度和刻度參考值：

刻度	溫度 (°C)	料理 (只供參考)
WARM	65-80	料理好的食物保溫
LOW	100-130	薄餅、蛋糕等
MED	160-200	漢堡、紅豆餅等
HIGH	190-245	烤肉、牛排、大阪燒、章魚丸子燒、火鍋、蒸煮等

- 上述溫度是以不合上鍋蓋、不放入食材下烤盤的表面溫度。
 - 不同的烤盤傳熱不同，烹飪時自行調節合適的溫度。
 - 使用深盤煮水或煮湯時，請不要超過最大水位線，煮沸後，若長時間蓋著鍋蓋，有水從盤的 4 個角溢出，這是由於長時間沸騰，蒸汽孔無法快速排出過多蒸汽，蒸汽凝結成水滴從蓋子邊緣流出，是正常現象。
 - 深鍋煮水時，水量不能超過最大水位線。
 - 使用時，禁止觸碰鍋身、烤盤、深鍋、蓋子，當心觸電和高溫燙傷。使用後，需等烤盤全部冷卻才可取出清洗。
 - 深鍋烤盤處於高溫狀態時，禁止直接使用水或清潔劑清洗，會損壞塗層，縮短塗層使用壽命。
4. 使用後，將溫度調節桿調回“OFF”位置，然後從插座上拔出電源插頭。待烤盤冷卻以後，戴上防燙手套從主機上取出烤盤，用軟布清潔。

OFF 位置

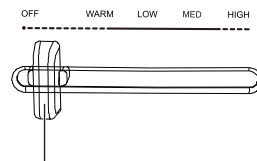

溫度調節杆

拔出電源

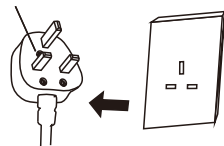

如何使用烤盤/深鍋

1. 烤盤：烤的時候利用蒸汽讓食物更鮮美，需要時配合鍋蓋使用。
烹飪時，將食物直接置與烤盤內，煎烤幾分鐘，在烤盤邊緣凹槽位置加入 1/4 杯的水，蓋上鍋蓋，將溫度調至最大。直至凹槽內水分完全蒸發，食物基本熟透即可取出食用。
2. 深鍋：煎、炒、烤、蒸、煮、火鍋等，需要時配合鍋蓋使用。
蒸架：需要配合深鍋，用於蒸各類食物。

清潔及維護保養

1. 每次使用後，要清潔多功能鍋的所有部件，以防止油脂積聚和避免留下烘烤味。
2. 清潔之前，請拔下電源插頭並確保所有烤盤/深鍋/蒸架都完全冷卻。
3. 不要將多功能鍋主機浸在水裡及在水龍頭下清洗。
4. 可以拆卸的深鍋、烤盤和蒸架在水中清洗，只能使用軟布清潔，不能放進洗碗機。
5. 清潔主機表面需用柔軟的濕布輕輕擦拭。
6. 不要使用研磨清潔劑或尖銳的器具清潔主機、配件和上蓋，會刮傷塗層。
7. 每次使用多功能鍋前必須先讓所有部件及主機表面保持乾爽。

產品規格

產品型號: GMC12V(紫色) GMC12P (粉紅色)

額定功率: 1200-1400W

電壓頻率: 220V~50/60Hz

產品尺寸(不包含配備容器): 390(寬) x 245(高) x 145(深) 毫米