

# FRIGIDAIRE®

## Washing Machine

### OWNER'S MANUAL

### FW712

#### Read This Manual

Use all instructions and explanations of the installation before use. Follow the instructions carefully. Keep the operation instructions handy for later use. If the application is sold or passed on then ensure that the new owner always receives those operation instructions.

# CONTENTS

---

## SAFETY INSTRUCTIONS

■ Safety Instructions .....	2
-----------------------------	---

## INSTALLATION

■ Product Description .....	7
■ Installation .....	8

## OPERATIONS

■ Quick Start .....	11
■ Before Each Washing .....	12
■ Detergent Dispenser .....	13
■ Control Panel .....	14
■ Option .....	15
■ Other Functions .....	16
■ Programmes.....	18
■ Washing Programmes Table .....	19

## MAINTENANCES

■ Cleaning And Care .....	20
■ Trouble Shooting .....	23
■ Technical Specifications .....	25

# SAFETY INSTRUCTIONS

---

## ■ Safety Instructions

For your safety, the information in this manual must be followed to minimize the risk of fire or explosion, electric shock, or to prevent property damage, personal injury or loss of life.

Explanation of the symbols:

### Warning!

This combination of symbol and signal word indicates a potentially dangerous situation which may result in death or serious injuries unless it's avoided.

### Caution!

This combination of symbol and signal word indicates a potentially dangerous situation which may result in slight or minor injuries or damage to property and the environment.

### Note!

This combination of symbol and signal word indicates a potentially dangerous situation which may result in slight or minor injuries.

### Warning!

The electric shock!

- If the supply cord is damaged, it must be replaced by the manufacturer, its service agent or similarly qualified persons in order to avoid a hazard.

# SAFETY INSTRUCTIONS

---

- The new hose-sets supplied with the appliance are to be used and that old hose-sets should not be reused.
- Before any maintenance the device, unplug the appliance from the mains.
- Always unplug the machine and turn off the water supply after use. The max. inlet water pressure, in pascals. The min. inlet water pressure, in pascals.
- To ensure your safety, power plug must be inserted into an earthed three-pole socket. Check carefully and make sure that your socket is properly and reliably earthed.
- Make sure that the water and electrical devices must be connected by a qualified technician in accordance with the manufacturer's instructions and local safety regulations.

## Risk to children!

- The appliance can be used by children aged from 8 years and above and persons with reduced physical, sensory or mental capabilities or lack of experience and knowledge if they have been given supervision or instruction concerning use of the appliance in a safe way and understand the hazards involved. Children shall not play with the appliance. Cleaning and user maintenance shall not be made by children without supervision.
- Children of less than 3 years should be supervised to ensure that they do not play with appliance.
- Animals and children may climb into the machine. Check the machine before every operation.
- Kids should be supervised that they do not play with the appliance.

## SAFETY INSTRUCTIONS

---

- Glass door may be very hot during the operation. Keep kids and pets far away from the machine during the operation very wet rooms as well as in the rooms with explosive or caustic gas.
- Remove all packages and transport bolts before using the appliance. Otherwise, serious damage may result.
- Plug must be accessible after installation.

### Risk of explosion!

- Do not wash or dry articles that have been cleaned in, washed in, soaked in, or dabbed with combustible or explosive substances( such as wax, oil, paint, gasoline, degreasers, dry-cleaning solvents, kerosene, etc.) This may result in fire or explosion.
- Before hand thoroughly rinse items of washing by hand.

### ⚠ Caution!

### Installing the product!

- This washing machine is for indoor use only.
- It isn't intended to be built-in using.
- The openings must not be obstructed by a carpet.
- Washing machine shall not be installed in bath room or very wet rooms as well as in the rooms with explosive or caustic gases.
- The washing machine with single inlet valve only can be connected to the cold water supply. The product with double inlet valves should be correctly connected to the hot water and cold water supply.
- Plug must be accessible after installation.

## SAFETY INSTRUCTIONS

---

- Remove all packages and transport bolts before using the appliance. Otherwise, serious damage may result.

### Risk of damaging appliance!

- Your product is only for home use and is only designed for the textiles suitable for machine washing.
- Do not climb up and sit on top cover of the machine.
- Do not lean against machine door.
- Cautions during Handling Machine:
  - 1.Transport bolts shall be reinstalled to the machine by a specialized person.
  - 2.The accumulated water shall be drained out of the machine.
  - 3.Handle the machine carefully. Never hold each protruded part on the machine while lifting. Machine door can not be used as the handle during the conveyance.
  - 4.This appliance is heavy. Transport with care.
- Please do not close the door with excessive forces. If it is found difficult to close the door, please check if the clothes are put in or distributed well.
- It is forbidden to wash carpets.

### Operating the appliance!

- Before washing the clothes at first time, the product shall be operated in one round of the whole procedures without the clothes inside.
- Flammable and explosive or toxic solvents are forbidden. Gasoline and alcohol etc. Shall not be used as detergents. Please only select the detergents suitable for machine washing, especially for drum.

# SAFETY INSTRUCTIONS

---

- Make sure that all pockets are emptied. Sharp and rigid items such as coin, brooch, nail, screw or stone etc. may cause serious damages to this machine.
- Please check whether the water inside the drum has been drained before opening its door. Please do not open the door if there is any water visible.
- Be careful of burning when the product drains hot washing water.
- Never refill the water by hand during washing.
- After the program is completed, Please wait for two minutes to open the door.

## Environment

Effective from 31 December 2018, the disposal licensing control, import and export permit control and landfill disposal ban in respect of abandoned regulated electrical equipment (REE) have commenced. Any person who is engaged in the storage, treatment, reprocessing or recycling of abandoned REE must obtain a waste disposal licence; a permit is required for the import and export of abandoned REE; and abandoned REE is no longer be accepted for disposal at the landfills and other designated waste disposal facilities (e.g. refuse transfer stations).



# INSTALLATION

## ■ Product Description

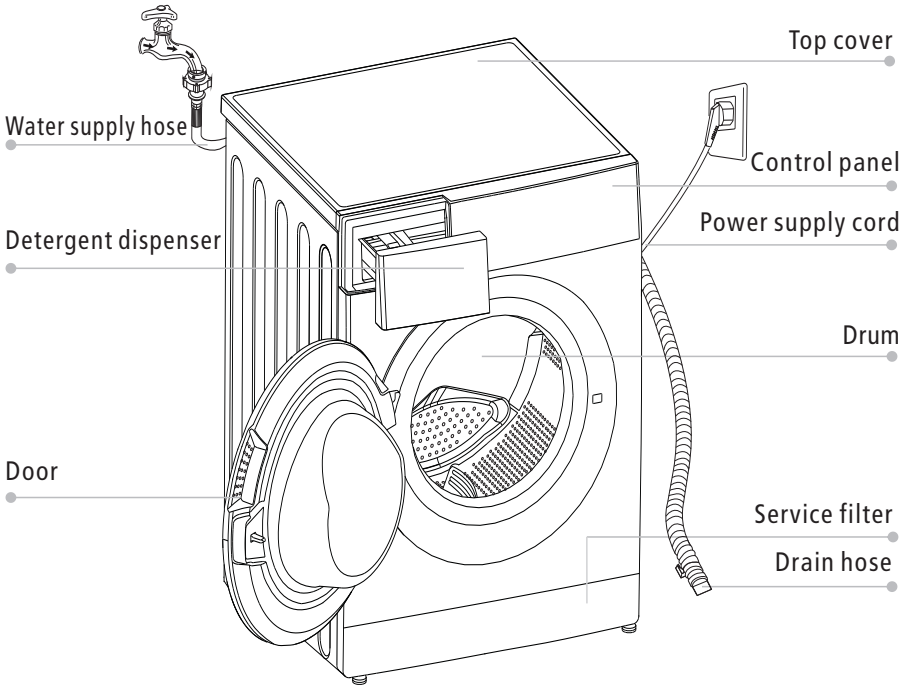

### Note!

- The product line chart is for reference only, please refer to real product as standard.

## Accessories

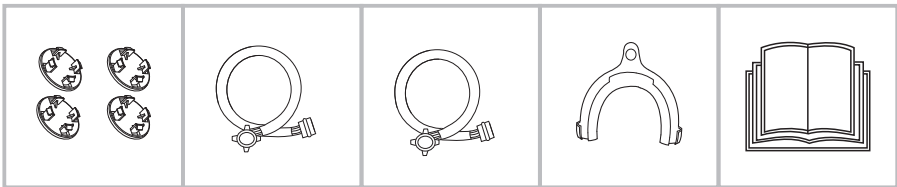

Transport hole plug

Supply hose cold water

Supply hose hot water (optional)

Drain hose support (optional)

Owner's manual



# INSTALLATION

## ■ Installation

### Installation area

#### ⚠ Warning!

- Stability is important to prevent the product from wandering!
- Make sure that the product should not stand on the power cord.

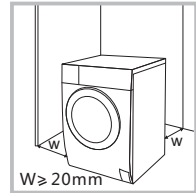

Before installing the machine, the location characterized as follows shall be selected:

1. Rigid, dry, and level surface
2. Avoid direct sunlight
3. Sufficient ventilation
4. Room temperature is above 0°C
5. Keep far away from the heat resources such as coal or gas.

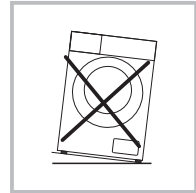

### Unpacking the washing machine

#### ⚠ Warning!

- Packaging material (e.g. Films, Styrofoam) can be dangerous for children.
- There is a risk of suffocation ! Keep all packaging well away from children.

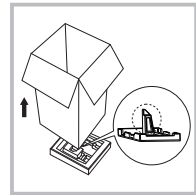

1. Remove the cardboard box and styrofoam packing.
2. Lift the washing machine and remove the base packing. Make sure the small triangle foam is removed with the bottom one together. If not, lay the unit down with side surface, then remove the small foam from the unit bottom manually.
3. Remove the tape securing the power supply cord and drain hose.
4. Remove the inlet hose from the drum.

### Remove transport bolts

#### ⚠ Warning!

- You must remove the transport bolts from the backside before using the product.
- You'll need the transport bolts again if you move the product, so make sure you keep them in a safe place.

Please take the following steps to remove the bolts:

1. Loosen 4 bolts with spanner and then remove them.
2. Stop the holes with transport hole plugs.
3. Keep the transport bolts properly for future use.

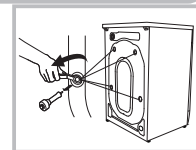

# INSTALLATION

## Levelling the washing machine

### ⚠ Warning!

- The lock nuts on all four feet must be screwed tightly against the housing.

1. Check if the legs are closely attached to the cabinet. If not, please turn them to their original positions tighten the nuts.
2. Loosen the lock nut turn the feet until it closely contacts with the floor.
3. Adjust the legs and lock them with a spanner, make sure the machine is steady.

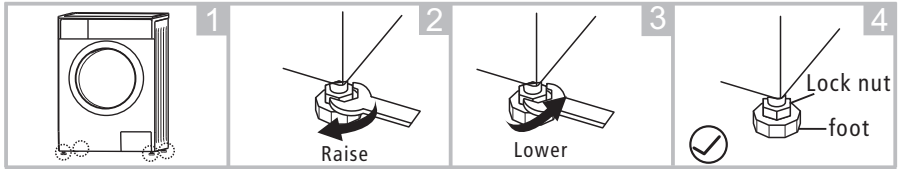

## Connect Water Supply Hose

### ⚠ Warning!

- To prevent leakage or water damage, follow the instructions in this chapter!
- Do not kink, crush, modify or sever water inlet hose.
- For the model equips hot valve, connect it to hot water tap with hot water supply hose. Energy consumption will decrease automatically for some program.

Connect the inlet pipe as indicated, There are two ways to connect the inlet pipe.

1. Connection between ordinary tap and inlet hose.

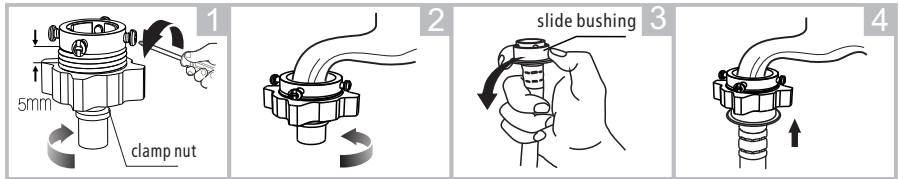

Loosen clamp nut and four bolts

Tighten clamp nut

Press slide bushing, insert inlet hose into connecting base

Connection finished

2. Connection between screw tap and inlet hose.

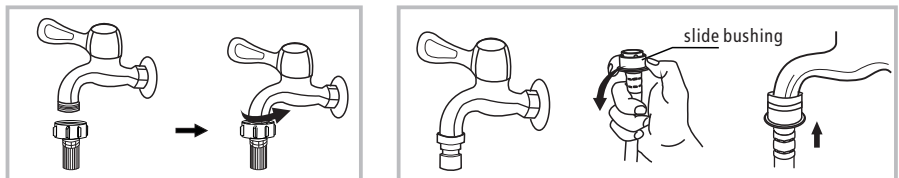

Tap with threads and inlet hose

Special tap for washing machine

# INSTALLATION

Connect the other end of inlet pipe to the inlet valve at the backside of product and fasten the pipe tightly clockwise.

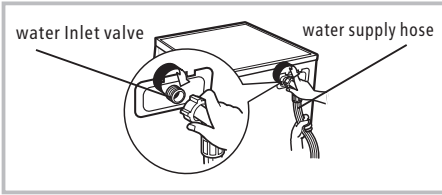

## Drain Hose

### ⚠ Warning!

- Do not kink or protract the drain hose.
- Position drain hose properly ,otherwise damage might result of water leakage.

There are two ways to place the end of drain hose:

1.Put it into the water trough.

2.Connect it to the branch drain pipe of the trough.

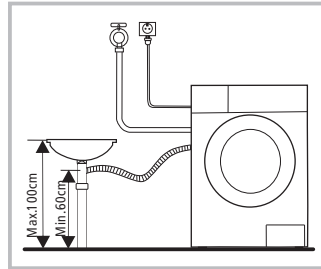
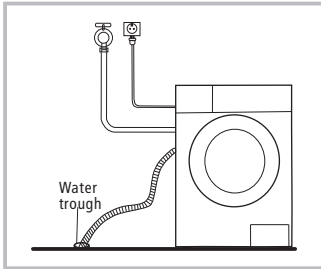

### 📌 Note!

- If the machine has drain hose support, please install it like the following .

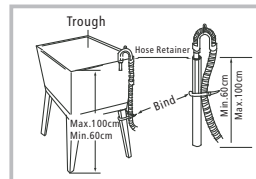
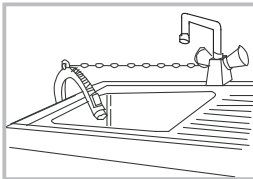

### ⚠ Warning!

- When installing drain hose, fix it properly with a rope.
- If drain hose is too long, do not force it into washing machine as it will cause abnormal noises.

# OPERATIONS

## ■ Quick Start

### ⚠ Caution!

- Before washing, please make sure it's installed properly.
- Before washing at first time, the washing machine shall be operated in one round of the whole procedures without clothes in as follows.

## 1. Before Washing

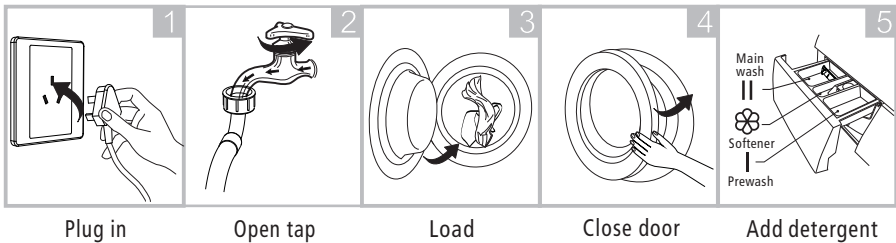

### 📌 Note!

- Detergent need to be added in "case I " after selecting pre-washing for machines with this function.

## 2. Washing

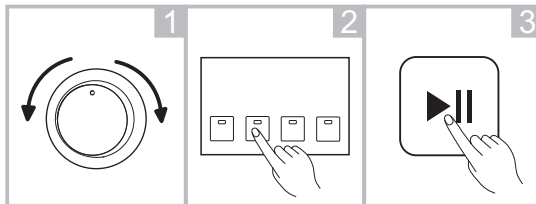

Select Programme      Select function or default      Start up

### 📌 Note!

- If default is selected, step 2 can be skipped.
- 2.The function button line chart is for reference only, please refer to real product as standard.

## 3. After Washing

The door lock and the [Start / Pause ] lights flash with the buzzer beeping or two small points flash on the digital screen.

# OPERATIONS

## ■ Before Each Washing

- The working condition of the washer should be (0-40)°C. If used under 0°C, the inlet valve and draining system may be damaged. If the machine is placed under condition of 0°C or less, then it should be transferred to normal ambient temperature to ensure the water supply hose and drain hose are not frozen before use.
- Please check the labels and the explanation of using detergent before wash. Use non-foaming or less-foaming detergent suitable for machine washing properly.

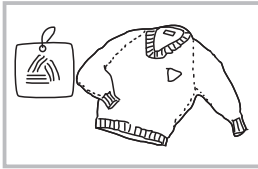

Check the label

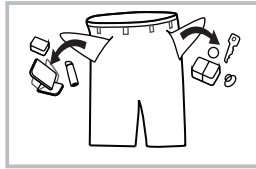

Take out the items out of the pockets

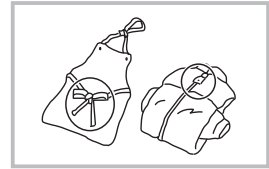

Knot the long strips, zip or button

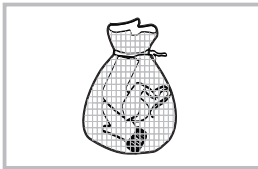

Put small clothes into the pillow slip

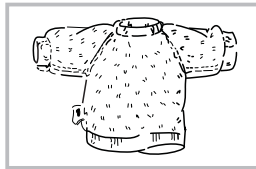

Turn easy-pilling and long-pile fabric inside out

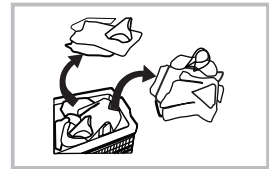

Separate clothes with different textures

## ⚠ Warning!

- When washing a single clothes, it may easily cause great eccentricity and give alarm due to great unbalance. Therefore it is suggested to add one or two more clothes to be washed together so that draining can be done smoothly.
- Don't washing the clothes touching with kerosene, gasoline, alcohol and other flammable materials.

# OPERATIONS

## ■ Detergent Dispenser

- I Prewash detergent
- II Main wash detergent
- ☼ Softener

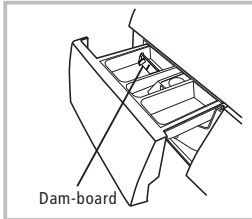

Liquid detergent

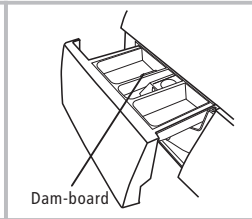

Powder detergent

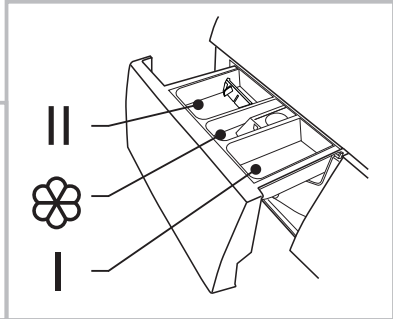

Pull out the dispenser

### ⚠ Caution!

- Detergent only need to be added in "case I " after selecting pre-washing for machines with this function.

Programme	I	II	☼	Programme	I	II	☼
Cotton Eco 40 °C	●	○	○	Spin Only			
Cotton Eco 60 °C	●	○	○	Drain Only			
Cotton	●	○	○	Rinse&Spin			○
Cotton 20 °C	●	○	○	Delicate 30 °C		●	○
Cotton 30 °C	●	○	○	Delicate		●	○
Cotton 40 °C	●	○	○	Mix 60 °C		●	○
Cotton 60 °C	●	○	○	Mix 40 °C		●	○
Cotton 90 °C	●	○	○	Mix		●	○
Synthetic	●	○	○	Daily Wash 45'		●	○
Synthetic 40 °C	●	○	○	Daily Wash 30'		●	○
Synthetic 60 °C	●	○	○	Daily Wash 15'		●	○
Drum Clean							

- Means must
- Means optional

### 📌 Note!

- As for the agglomerated or ropy detergent or additive, before they are poured into the detergent box, it is suggested to use some water for dilution to prevent the inlet of detergent box from being blocked and overflowing while filling water.
- Please choose suitable type of detergent for the various washing temperature to get the best washing performance with less water and energy consumption.

# OPERATIONS

## ■ Control Panel

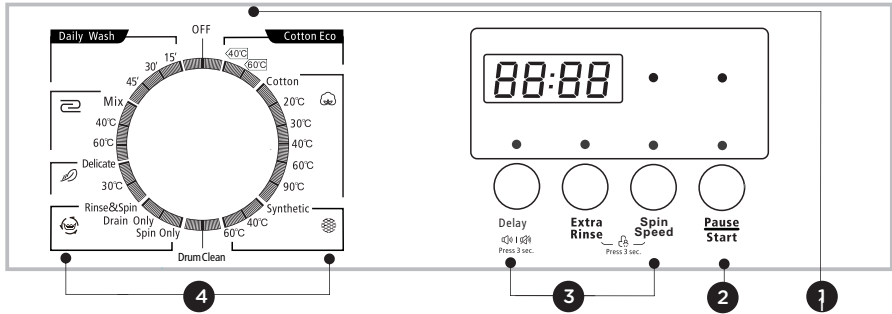

### Note!

- The chart is for reference only, Please refer to real product as standard.

#### 1 Off

Product is switched off.

#### 2 Start/Pause

Press the button to start or pause the washing cycle.

#### 3 Option

This allows you to select an additional function and will light when selected.

#### 4 Programmes

Available according to the laundry type.

# OPERATIONS

---

## ■ Option

**Extra Rinse:** The laundry will undergo extra rinse once after you select it.

---

**Delay:** Delay function can be set with this button, the delaying time is 0-24H.

---

**Spin Speed:** It can be set the spin speed to press the button repeatedly

---



# OPERATIONS

Programme	Option	Programme	Option
	extra Rinse		extra Rinse
Cotton Eco 40 °C		Drain Only	
Cotton Eco 60 °C		Rinse&Spin	○
Cotton	○	Delicate 30 °C	○
Cotton 20 °C	○	Delicate	○
Cotton 30 °C	○	Mix 60 °C	○
Cotton 40 °C	○	Mix 40 °C	○
Cotton 60 °C	○	Mix	○
Cotton 90 °C	○	Daily Wash 45'	
Synthetic	○	Daily Wash 30'	
Synthetic 40 °C	○	Daily Wash 15'	
Synthetic 60 °C	○		
Drum Clean			
Spin Only			

- Means optional

## ■ Other Functions



Mute the buzzer



Choose the Programme Press the [Delay] button for 3sec.the buzzer is mute.

To act the buzzer function, press the button again for 3 seconds. The setting will be kept until the next reset.

### ⚠ Caution!

- After Muting the buzzer function, the sounds will not be activated any more.

# OPERATIONS



**Child Lock**  
To avoid mis operation by children.



Choose the Programme



Start



Press [Extra Rinse] and [Spin Speed] 3 sec. till buzzer beep.

## ⚠ Caution!

- Press the two button 3sec. also to be released the function.
- The “Child Lock” will lock all buttons except [OFF].
- Cut off the power supply , the kid’s protection is to be released.
- If you want to change the program on child lock condition, you should unlock the child lock first, then rotate the knob to OFF position, finally choose the program you want.

## Temp.

The temperature is: Cold, 20°C, 30°C, 40°C, 60°C, 90°C

## Speed

The speed is:

1200: 0-400-600-800-1000-1200

Programme	Default Speed(rpm)	Programme	Default Speed(rpm)
	1200		1200
Cotton Eco 40 °C	1200	Spin Only	1200
Cotton Eco 60 °C	1200	Drain Only	-
Cotton/Normal	1200	Rinse&Spin	1200
Cotton/Normal 20 °C	1200	Delicate 30 °C	600
Cotton/Normal 30 °C	1200	Delicate	600
Cotton/Normal 40 °C	1200	Ends in 9H/Mix 60 °C	1000
Cotton/Normal 60 °C	1200	Ends in 6H/Mix 40 °C	1000
Cotton/Normal 90 °C	1200	Ends in 3H/Mix	1000
Synthetic	1000	Daily Wash 45'	800
Synthetic 40 °C	1000	Daily Wash 30'	800
Synthetic 60 °C	1000	Daily Wash 15'	800
Drum Clean	400		

# OPERATIONS

---

## ■ Programmes

Programmes are available according to the laundry type.

### Programmes

Cotton/Normal	Hard-wearing textiles, heat-resistant textiles made of cotton or linen.
---------------	---

Synthetic	Wash synthetic articles, for example: shirts, coats, blending. While washing the knitting textiles, detergent quantity shall be reduced due to its loose string construction and easily forming bubbles.
-----------	--

Daily Wash	It is suitable for washing few and not very dirty clothes quickly.
------------	--

Cotton Eco	To increase the washing effects, washing time is increased.
------------	---

Delicate	For delicate, washable textiles, e.g. made of silk, satin, synthetic fibres or blended fabrics.
----------	---

Drum Clean	It applies 90 °C high temperature sterilization to make the clothes washing more green. When this procedure is performed, the clothes or other washing cannot be added. When proper amount of chlorine bleaching agent is put in, the barrel cleaning effect will be better. The customer can use this programme regularly according to the need.
------------	---

Spin Only	Extra spin
-----------	------------

Rinse & Spin	Extra rinse with spin.
--------------	------------------------

Drain Only	Drain off the water.
------------	----------------------

Mix	You can select this procedure wash the tough clothes, that need much more time and strength. It is used for the daily clothes of cotton, such as sheets, chains, pillow cases bathrobe and underwear.
-----	---

# OPERATIONS

Programme	Load(kg)	Temp.(°C)	Default Time
	7.0	Default	7:0
			12:00
Cotton Eco 40 °C	7.0	40	3:34
Cotton Eco 60 °C	7.0	60	3:53
Cotton	7.0	Cold	1:35
Cotton 20 °C	7.0	20	1:19
Cotton 30 °C	7.0	30	1:20
Cotton 40 °C	7.0	40	1:40
Cotton 60 °C	7.0	60	1:45
Cotton 90 °C	7.0	90	2:40
Synthetic	3.5	Cold	1:18
Synthetic 40 °C	3.5	40	1:33
Synthetic 60 °C	3.5	60	1:43
Drum Clean	-	90	1:21
Spin Only	7.0	-	0:12
Drain Only	-	-	0:01
Rinse&Spin	7.0	-	0:31
Delicate 30 °C	2.5	30	1:00
Delicate	2.5	Cold	0:55
Mix 60 °C	7.0	40/60	1:23
Mix 40 °C	7.0	40	1:02
Mix	7.0	Cold	1:13
Daily Wash 45'	2.0	30	0:45
Daily Wash 30'	2.0	20	0:30
Daily Wash 15'	2.0	Cold	0:15

## Note!

- The parameters in this table are only for user's reference. The actual parameters may be different with the parameters in above mentioned table.

# MAINTENANCES

---

## ■ Cleaning And Care

### Warning!

- Before your maintenance starts, please unplug the machine and close the tap.

## Cleaning The Cabinet

Proper maintenance on the washing machine can extend its working life. The surface can be cleaned with diluted non-abrasive neutral detergents when necessary. If there is any water overflow, use the wet cloth to wipe it off immediately. No sharp items are allowed.

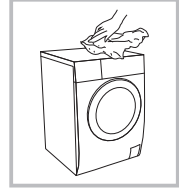

### Note!

- Formic acid and its diluted solvents or equivalent are forbidden, such as alcohol, solvents or chemical products, etc.

## Cleaning The Drum

The rusts left inside the drum by the metal articles shall be removed immediately with chlorine-free detergents. Never use steel wool.

### Note!

- Don't put laundry in the washing machine during the drum cleaning.

## Cleaning The Door Seal And Glass

Wipe the glass and seal after each wash to remove lint and stains. If lint builds up it can cause leaks. Remove any coins, buttons and other objects from the seal after each wash.

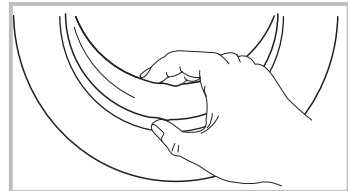

# MAINTENANCES

## Cleaning The Inlet Filter

### Note!

- Inlet filter must be cleaned if there is less water.

### Washing the filter in the tap

1. Close the tap.
2. Remove the water supply hose from the tap.
3. Clean the filter.
4. Reconnect the water supply hose.

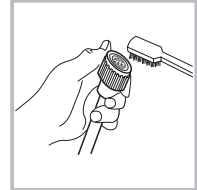
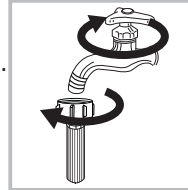

### Washing the filter in washing machine:

1. Screw off the inlet pipe from the backside of the machine.
2. Pull out the filter with long nose pliers and reinstall it back after being washed.
3. Use the brush to clean the filter.
4. Reconnect the inlet pipe.

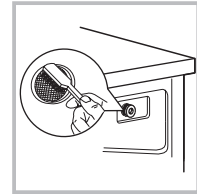
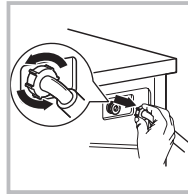

### Note!

- If the brush is not clean, you can pull out the filter washed separately;
- Reconnect, turn on the tap.

## Clean The Detergent Dispenser

1. Press down the arrow location on softener cover inside the dispenser drawer.
2. Lift the clip up and take out softener cover and wash all grooves with water.
3. Restore the softener cover and push the drawer into position.

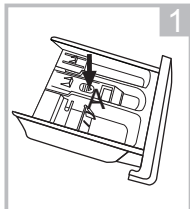

Pull out the dispenser drawer with press the A

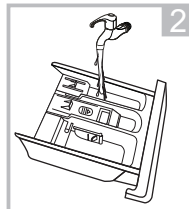

Clean the dispenser drawer under water

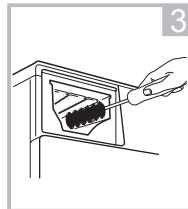

Clean inside the recess with an old toothbrush

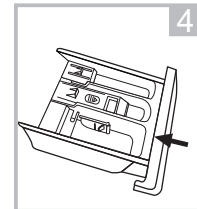

Insert the dispenser drawer

### Note!

- Do not use alcohol, solvents or chemical products to clean the machine.

# MAINTENANCES

## Cleaning The Drain Pump Filter

### ⚠ Warning!

- Be careful of the hot water!
- Allow detergent solution to cool down.
- Unplug the machine to avoid electrical shock before washing.
- Drain pump filter can filter the yarns and small foreign matters from the washing.
- Clean the filter periodically to ensure the normal operation of washing machine.

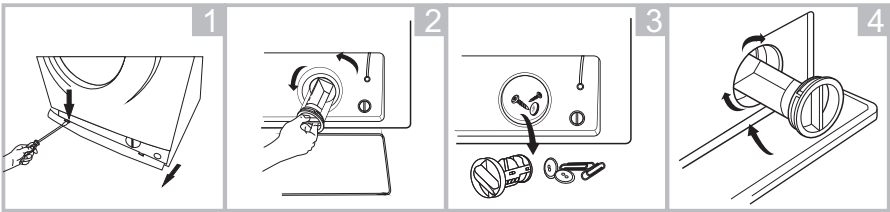

1 Open the Service filter

2 Open the filter by turning to the counter clockwise

3 Remove extraneous matter

4 Close the lower cover cap

### ⚠ Caution!

- Make sure that valve cap and emergency drain hose are reinstalled properly, cap plates should be inserted aligning to hole plates otherwise water may leak;
- Some machines don't have emergency drain hose, rotate lower cover cap directly to make water run into basin.
- When the appliance is in use and depending on the programme selected there can be hot water in the pump. Never remove the pump cover during a wash cycle, always wait until the appliance has finished the cycle, and is empty. When replacing the cover, ensure it is securely re-tightened.

# MAINTENANCES

## ■ Trouble Shooting

The start of the appliance does not work or it stops during operation.  
 First try to find a solution to the problem, If not, contact the service centre.

Description	Reason	Solution
Washing machine cannot start up	Door is not closed properly	Restart after the door is closed Check if the clothes is stuck
Door can't be opened	Washer's safety protection design is working	Disconnect the power, restart the product
Water leakage	The connection between inlet pipe or outlet hose is not tight	Check and fasten water pipes Clean up outlet hose
Detergent residues in the box	Detergent is dampened or agglomerated	Clean and wipe the detergent box
Indicator or display does not light	Disconnect the power PC board or harness has connection problem	Check if the power is shut down and the power plug is connected correctly
Abnormal noise		Check if the fixing (bolts) have been removed Check it's installed on a solid and level floor

Description	Reason	Solution
Flash Off	Door is not closed properly	Restart after the door is closed Check if the clothes is stuck
Off		
Flash Off	Water injecting problem while washing	Check if the water pressure is too low Straighten the water pipe Check if the inlet valve filter is blocked
Off		
Flash Off	Overtime water draining	Check if the drain hose is blocked
Off		
Flash Off	Water overflow	Restart the washer
Off		
	Others	Please try again first, call up service line if there are still troubles



# MAINTENANCES

---

Description	Reason	Solution
E30	Door is not closed properly	Restart after the door is closed Check if the clothes is stuck
E10	Water injecting problem while washing	Check if the water pressure is too low Straighten the water pipe Check if the inlet valve filter is blocked
E21	Overtime water draining	Check if the drain hose is blocked
E12	Water overflow	Restart the washer
Others	Please try again first, call up service line if there are still troubles	



## Note!

- After the check, activate the appliance. If the problem occurs again, contact the service.

# MAINTENANCES

## ■ Technical Specifications

Power Supply 220-240V~,50Hz

MAX.Current 10A

Standard Water Pressure 0.05MPa~1MPa

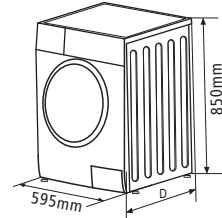

Model	Washing Capacity	Dimension (W*D*Hmm)	Net Weight	Rated Power
FW712	7.0kg	595*495*850	61kg	1950W(220V)